

FULL C.C.W. POSITION

文管中心  
2011.11.24  
發行章

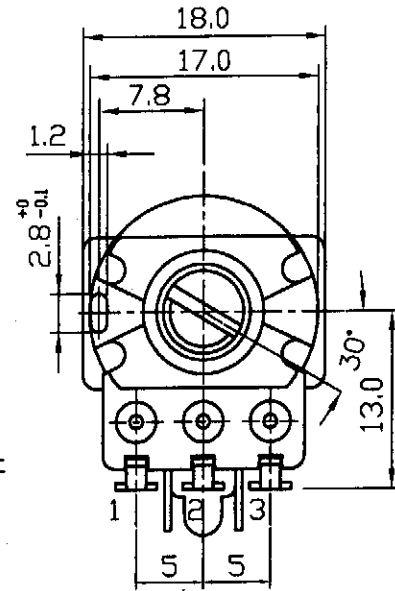
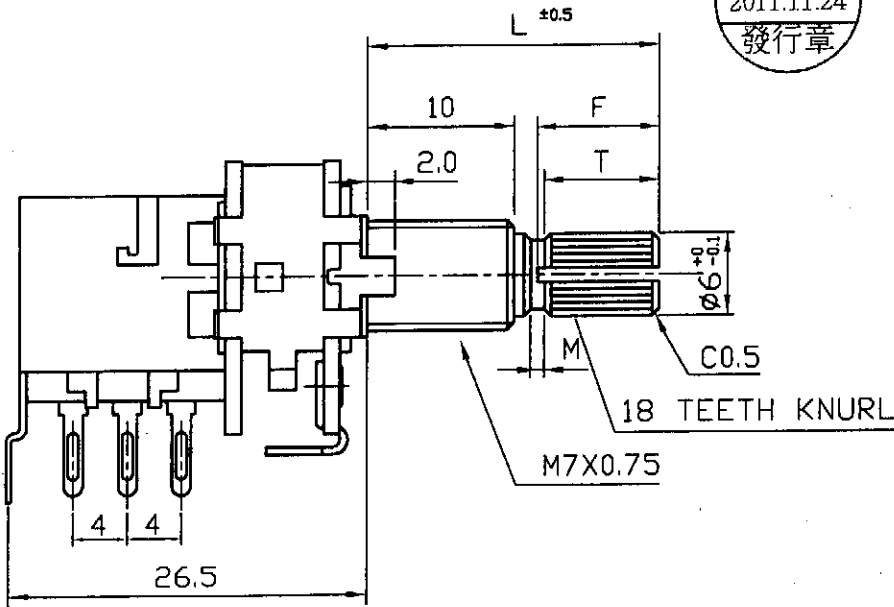

L	T	F	M
15	3	3.5	1
18	6	6.5	1
20	6	7	2

● 300° ROTATION  
MONO UNIT WITH SWITCH  
(SW PUSH PULL SWITCH)  
D,P,D,T DC 30V 0.3A

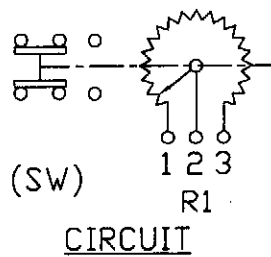

石研  
2011-11-29  
收文日  
電子部

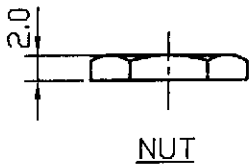
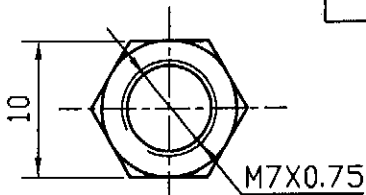

NUT

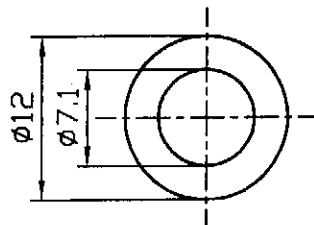

WASHER t=0.4

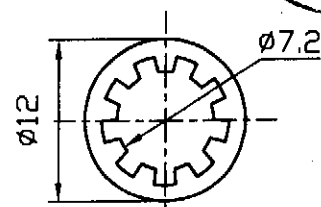

TEETH WASHER t=1.0

RV16BF-10B6-(L)K-XXX(-0044)

NO. DATE DESCRIPTION MODEL NAME

TOL. UNLESS OTHERWISE STATED	DIMENSION	SCALE	DRAWN BY	CHECKED BY	APPROVED BY	DRAWING NO.
less than 10 ±0.3	mm	2:1	李 2011.11.18 延玲		劉 2011.11.18 全紅	
above 10 ~ 30 ±0.5						
above 30 ~ 100 ±1.0						
above ±0.5						